

# 940nm 3W Single Diode Laser

## Applications

- Medical illumination
- Target Indication
- Laser Show
- Stage Lighting



## Parameters (20°C)

COS/F Package Single Laser Diode			
Parameter		Unit	LDMC-0940-003W-*3
Optical Parameter	Output power	W	3
	Lasing Wavelength	nm	940±10
	Spectral Width	nm	≤3
	Emitting Area width	μm	100
	Temperature Coefficient	nm/°C	0.30
	Fast Axis Divergence	deg	<40
	Slow Axis Divergence	deg	<10
Electrical Parameter	Slope Efficiency	W/A	≥1.03
	Threshold Current	A	≤0.50
	Operating Current	A	≤3.30
	Operating Voltage	V	<2.00
Others	Package	-	COS/F Package
	Operating Temperature	°C	15 ~ 30
	Storage Temperature	°C	-40 ~ 60



## Package Information

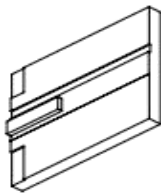
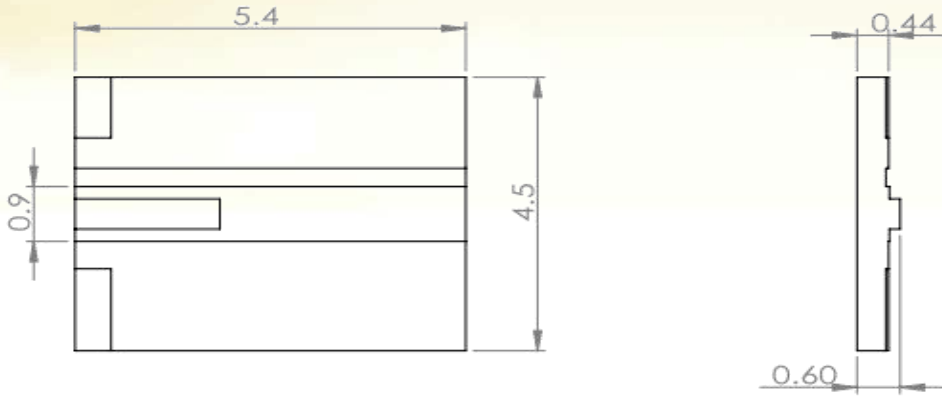

COS Package

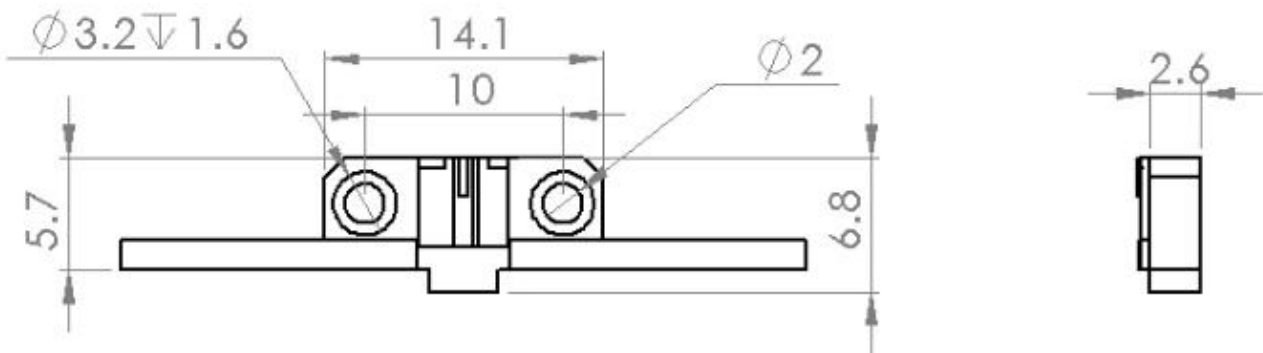

F Package





海特光电有限责任公司  
Hi-Tech Optoelectronics Co.,Ltd.

## Notice

---

1. Item model notice: LDM(Item model),\*\*\*\*( Center wavelength),\*\*\*\*(Output power), \*\*(Heat sink structure and item width).
2. Data in the sheet are all basis on C-mount package heat sink testing.
3. For more information, please contact Hi-Tech Optoelectronics Co., Ltd.



Add: Shahe Industrial Park, Changping District, Beijing, China  
Tel: +86-10-6076 9887      Fax: +86-10-6076 9887-699  
Web: [www.htoe.com.cn](http://www.htoe.com.cn)      Email: [sales@htoe.com.cn](mailto:sales@htoe.com.cn)

