

808nm 5W Single Diode Laser(AuSn)

Applications

- Medical Illumination
- Target Indication
- Laser Show
- Stage Lighting



Parameters (20°C)

C-Mount/TO3 Single Diode Laser (AuSn)					
Item	Parameter	Unit	LDM-0808-005W-*5		
			Min.	Typical	Max.
Optical Parameter	Output power	W	-	5	-
	Lasing Wavelength	nm	803	808	813
	Spectral Width	nm	-	1.8	3.0
	Emitting Area width	μm	-	200	-
	Temperature Coefficient	nm/°C	-	0.30	-
	Fast Axis Divergence	deg	-	34	38
	Slow Axis Divergence	deg	-	7	10
Electrical Parameter	Slope Efficiency	W/A	1.00	-	-
	Threshold Current	A	-	1.05	1.10
	Operating Current	A	-	5.20	5.50
	Operating Voltage	V	-	2.10	2.50
Others	Package	-	C-Mount/TO3		
	Operating Temperature	°C	10 ~ 50		
	Storage Temperature	°C	-10 ~ 60		



Package Information

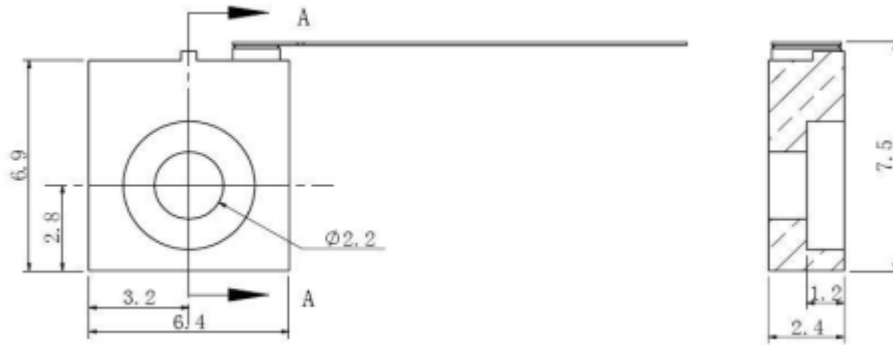

C-Mount Package

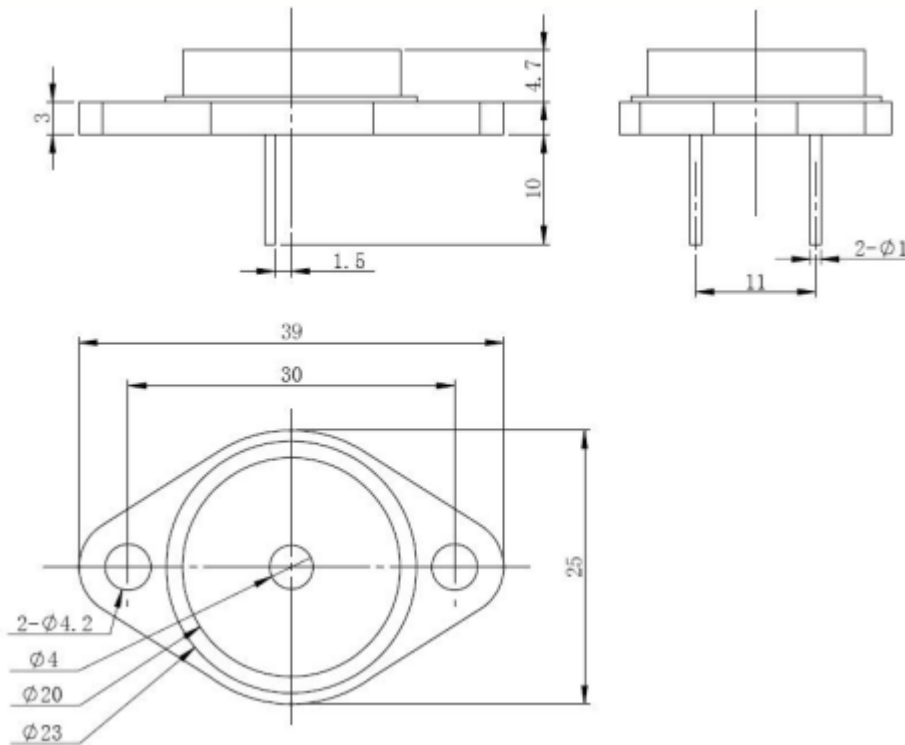

T03 Package





海特光电有限责任公司
Hi-Tech Optoelectronics Co.,Ltd.

Notice

1. Item model notice: LDM(Item model),****(Center wavelength),****(Output power), **(Heat sink structure and item width).
2. Data in the sheet are all basis on C-mount package heat sink testing.
3. For more information, please contact Hi-Tech Optoelectronics Co., Ltd.



Add: Shahe Industrial Park, Changping District, Beijing, China
Tel: +86-10-6076 9887 Fax: +86-10-6076 9887-699
Web: www.htoe.com.cn Email: sales@htoe.com.cn

